

# Pilot control unit with end position lock for the remote control of directional valves

RE 64 557/02.07 1/12

Replaces: 03.06

Type 4THF5 or 6THF5

Series 1X



## Contents

Functional description, section, symbol	2
Technical data	3
Ordering details	4
Characteristic curves	5
Unit dimensions	6 and 7
Variations of ergonomic grip EC2000	8
Contact location within the plugs for wiring grip EC2000	9
Contact location within the plugs for wiring the solenoids of the electro-magnetic lock	10
Guidelines	11

## Special features

- Progressive, sensitive operation.
- Precise and play-free control.
- Low actuation forces at lever.
- Several ergonomic grips with various E contacts (design patents).
- Electro-magnetic end position lock for holding the control lever in its deflected position.  
The electro-magnetic lock may be released by operating a switch on the machine.
- Noticeable resistance point when operating close to the lever end position (summation of progressive force), hence providing a warning just before the changeover occurs to the locked position or float position (prevention of accidental operation).



## Technical data (for applications outside these parameters, please consult us!)

Mechanical		
Back pressure at port T	bar	up to 3
Pilot oil flow (P to 1 - 2 - 3 - 4)	l/mn	up to 13
Pressure fluid <sup>1)</sup> suitable for NBR seals		Mineral oil (HL, HLP) to DIN 51524 <sup>1)</sup>
Pressure fluid temperature range	°C	-20 to +80
Viscosity range	mm <sup>2</sup> /s	10 to 380
Degree of pressure fluid contamination		to NAS 1638 class 9. We, therefore, recommend a filter with a minimum retention rate of $\beta_{10} \geq 75$
Max. permissible operating torque at lever	Nm	10 during operation
	Nm	80 with an exceptional, one time loading
Weight, version 4 THF 5	kg	approx. 3,5
Weight, version 6 THF 5	kg	approx. 4,9

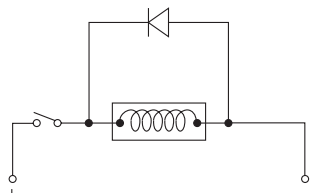
Electrical		
Technical data for the grips switch EC2000		
• Switching capacity		
– minimal current	resistive load	100mA at 12VDC or 24VDC
– maximal current	resistive load	5A at 12VDC or 24VDC
• Microswitch lifetime		
– resistive load at 12VDC	100 to 500mA	5 millions cycles
	5A	300000 cycles
– resistive load at 24VDC	100 to 500mA	3 millions cycles
	5A	150000 cycles
– inductive load L/R=5ms at 12VDC or 24VDC	1,25A	200000 cycles
• Maximal contact resistance	m Ω	20
• Switching on/off with low loads		
– minimum voltage	V	12
– minimum current strength	mA	100
• E-contact type		high current
Grip protection		IP65
Switching guidelines for DC voltages		to ensure the service life of the electrical switch, we recommend the use of free-wheeling diodes that are switched parallel to the inductivity. 
• Power supply for the locking solenoids	V	12 V (9 to 15) and 24 V (20 to 27) / DC
• Max. power consumption of each solenoid	W	13,5 at 12 VDC or 24VDC

# Ordering details

## Single pilot control unit 4 / 6 THF 5

	THF5		06	1X	-	/										M	*
--	------	--	----	----	---	---	--	--	--	--	--	--	--	--	--	---	---

**Number of control ports**

4 ports = 4  
6 ports = 6

**Grip ranges :**

Ergonomic EC2000 = E  
Ergonomic EC4000 = H  
Ergonomic EC2000+ = I  
Customer's no code  
Without grip = Z

**Control curve** (see page 5)

Curve 06 = 06  
Curve 70 = 70

Series 10 to 19 = 1X  
(10 to 19: unchanged installation and connection dimensions)

**Type of ergonomic grip**

Grip type E (see page 8) = TT, ST, VT, YT, YU  
Grip type H or I see datasheet RE 64547  
Without grip no code

**Grip orientation** (see pages 6-7)

Lever curved 15° towards control port 4 and grip towards control port 1 = 41  
Without grip no code

**End position lock per control port**

Without lock, without resistance point before changeover to inlet pressure = A <sup>1)</sup>  
With electro-magnetic lock 24 V and resistance point before changeover to inlet pressure (except control port 2) = C  
With electro-magnet lock 24 V, without resistance point (except control port 2) = D  
With electro-magnetic lock 12 V and resistance point before changeover to inlet pressure (except control port 2) = E  
With electro-magnetic lock 12 V, without resistance point (except control port 2) = F

«control port 1»  
«control port 2»  
«control port 3»  
«control port 4»  
«control port 5»  
«control port 6»

Further details in clear text

**Connection threads**

01 = G 1/4 pipe thread to standard ISO 228/1  
02 = M 14 x 1,5 metric to standard ISO 9974  
05 = 9/16 UNF-2B to standard ISO 11926

**Seals type**

M = NBR seals  
 Attention!  
the compatibility of the seals and pressure fluid has to be taken into account

**Plugs**

5 = DEUTSCH sealed plugs IP67 for the wiring of the grip and solenoids (see pages 9-10)  
6 = AMP MAT-N-LOK plugs for the wiring of the grip and solenoids (see pages 9-10)  
no code without plug

<sup>1)</sup> For the 4THF5: 3 control ports without lock maximum.

# Characteristic curves : control ranges, actuation moments

## 06 Control curve, identification No. 06

This curve is used for the pilot control of the SM12, M6 control blocks

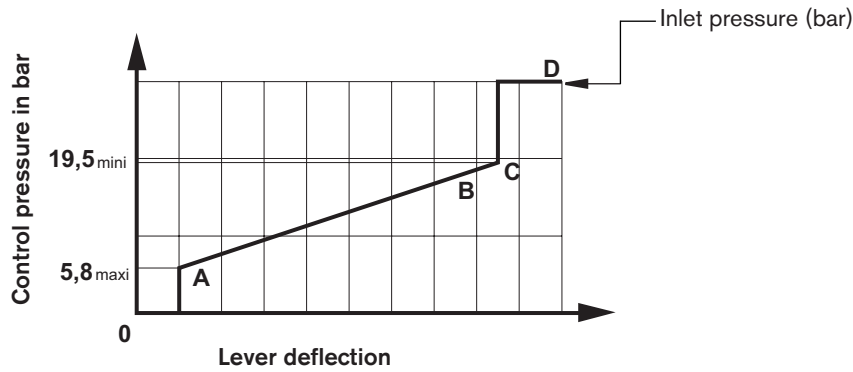

B = Resistance point before changeover to inlet pressure

## 70 Control curve, identification No. 70

This curve is used for the pilot control of the SX12, SX14, SX18 control blocks

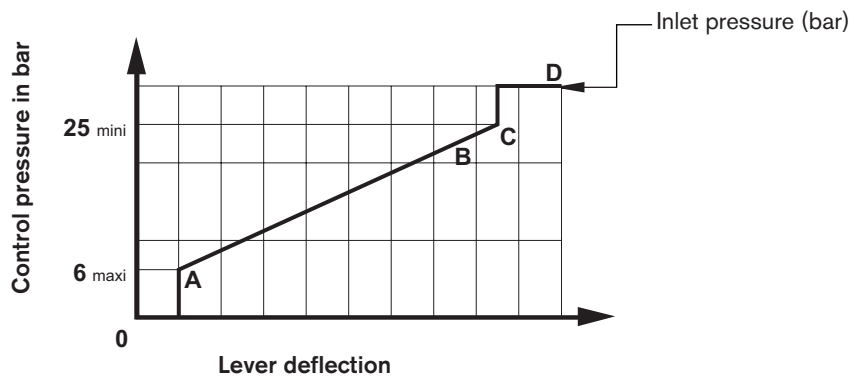

B = Resistance point before changeover to inlet pressure

Actuation moments of 1 actuator				
Inter-section point	A	B	C	D
Lever deflection	2°	16°	18°	20°
Operating torque without detent in N.m	0,8		2,2	3,6 (p = 35 bar)
Operating torque with detent in N.m	0,8	3,4	3,6	5,2 (p = 35 bar)

The operating torques stated are theoretical values which do not take into account the rubber boot resistance.

# Unit dimensions (dimensions in mm)

Type designation of the pilot control units shown: **4 THF 5 E...-1X / TT 41**

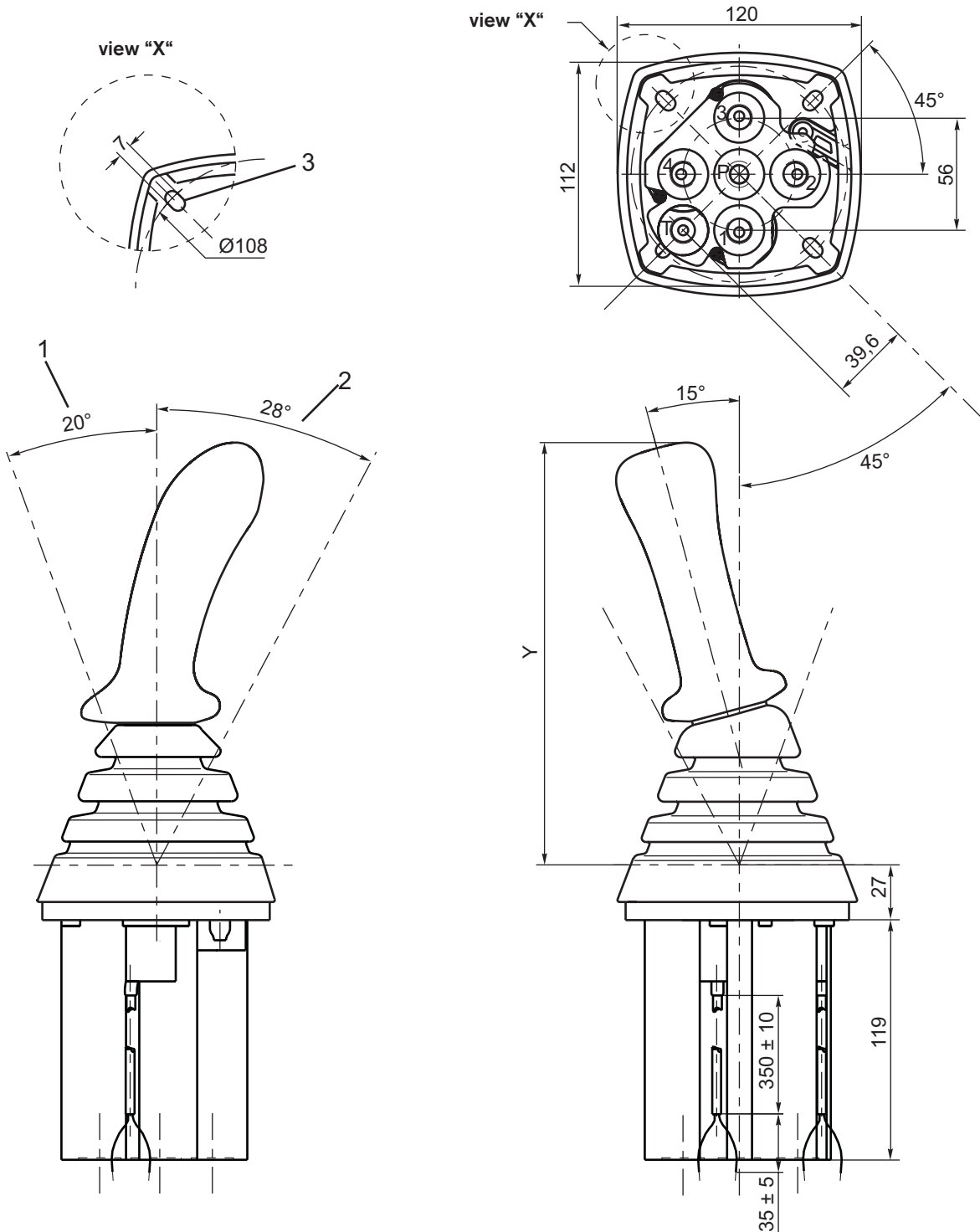

The 4 THF 5 variants are supplied without fixing screws nor shims









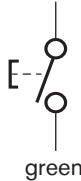

- 1 lever deflection when operating one actuator
- 2 lever deflection when operating two actuators
- 3 four equally space mounting points

### Unit dimension in function of the grip type :

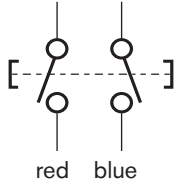
type of grip	Y
EC2000	208
EC2000+	220
EC4000	254

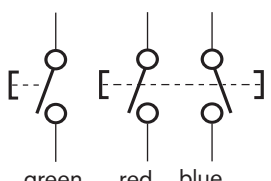

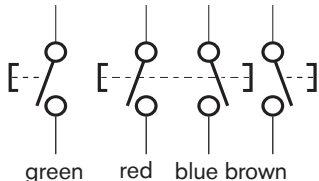
# Variations of ergonomic grip EC2000

<p><b>TT</b></p> 	<ul style="list-style-type: none"> <li>- without E-contact</li> </ul>	
<p><b>ST</b></p> 	<ul style="list-style-type: none"> <li>- single E-contact on top</li> </ul>	<p>yellow</p>  <p>green</p> 
<p><b>VT</b></p> 	<ul style="list-style-type: none"> <li>- double E-contact with rocker switch</li> </ul>	<p>black grey</p>  <p>red blue</p> 
<p><b>YT</b></p> 	<ul style="list-style-type: none"> <li>- double E-contact with rocker switch</li> <li>- single E-contact on top</li> </ul>	<p>yellow black grey</p>  <p>green red blue</p> 
<p><b>YU</b></p> 	<ul style="list-style-type: none"> <li>- double E-contact with rocker switch</li> <li>- single E-contact on top</li> <li>- single E-contact to the front</li> </ul>	<p>yellow black grey white</p>  <p>green red blue brown</p> 



# Contact location within the plugs for wiring grip EC2000

**DEUTSCH sealed plug IP 67**  
(ordering detail = 5)

**Plug AMP MAT-N-LOCK**  
(ordering detail = 6)

**Grip ST**

**Grip ST**

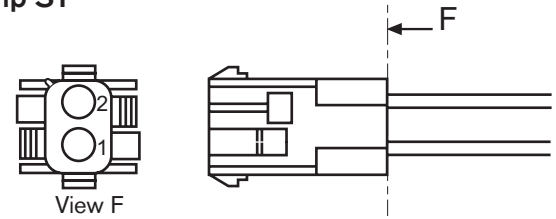
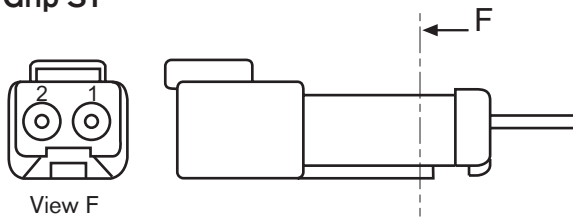

cover DEUTSCH DT 04 - 2P - CE 04

cover AMP 350778 - 1

**Grip VT or YT**

**Grip VT or YT**

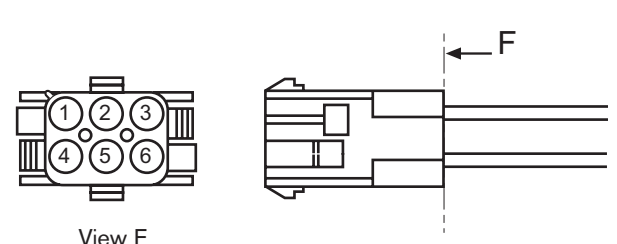
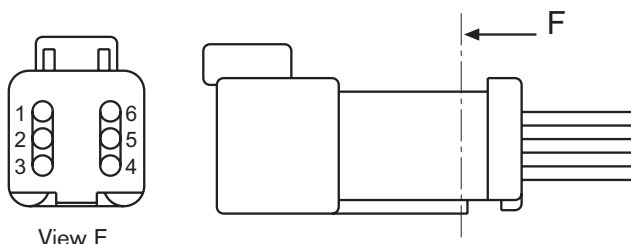

cover DEUTSCH DT 04 - 6P - CE 04

cover AMP 350781 - 1

Identification in the plug	wire colour	Ergonomic grip type	
		VT	YT
1	red	X	X
2	black	X	X
3	grey	X	X
4	blue	X	X
5	yellow		X
6	green		X

Identification in the plug	wire colour	Ergonomic grip type	
		VT	YT
1	grey	X	X
2	black	X	X
3	red	X	X
4	blue	X	X
5	yellow		X
6	green		X

**Grip YU**

**Grip YU**

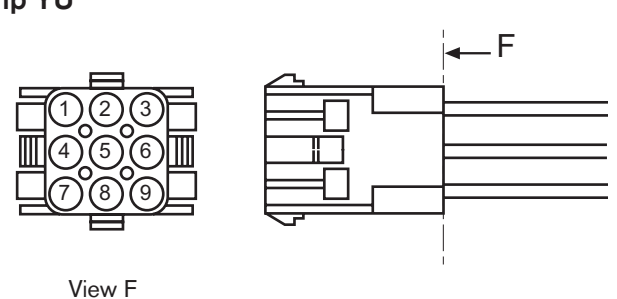
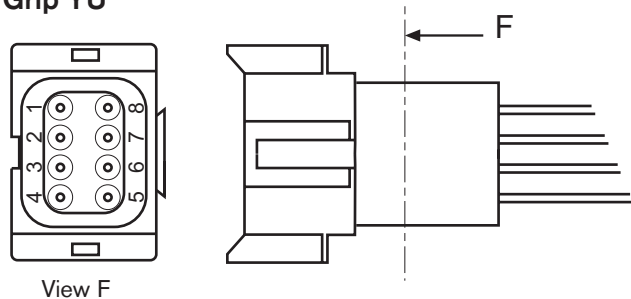

cover DEUTSCH DT 04 - 8P - CE 04

cover AMP 350782 - 1

Identification in the plug	wire colour	identification in the plug	wire colour
1	red	5	yellow
2	black	6	green
3	grey	7	white
4	blue	8	brown

Identification in the plug	wire colour	identification in the plug	wire colour
1	grey	5	yellow
2	black	6	green
3	red	7	white
4	blue	8	brown

# Contact location within the plugs for wiring the solenoids of the electro-magnetic lock

## DEUTSCH sealed plug IP 67 (ordering code = 5)

- Plug for wiring the 4/6 THF 5 electro-magnetic lock solenoids (ports 1, 3, 4)

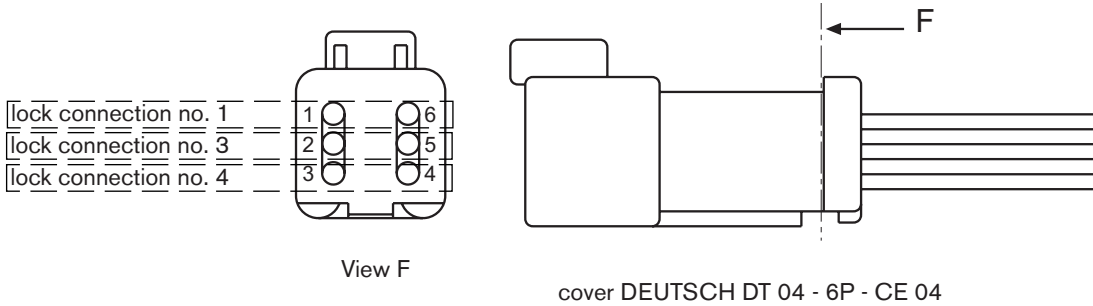

- Plug for wiring the 6 THF 5 electro-magnetic lock solenoids (ports 5, 6)

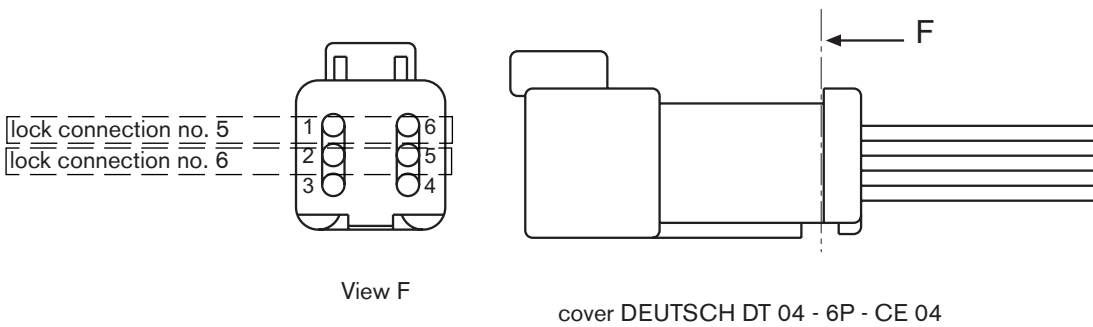

## Plug AMP MAT-N-LOK (ordering code = 6)

- Plug for wiring the 4/6 THF 5 electro-magnetic lock solenoids (ports 1, 3, 4)

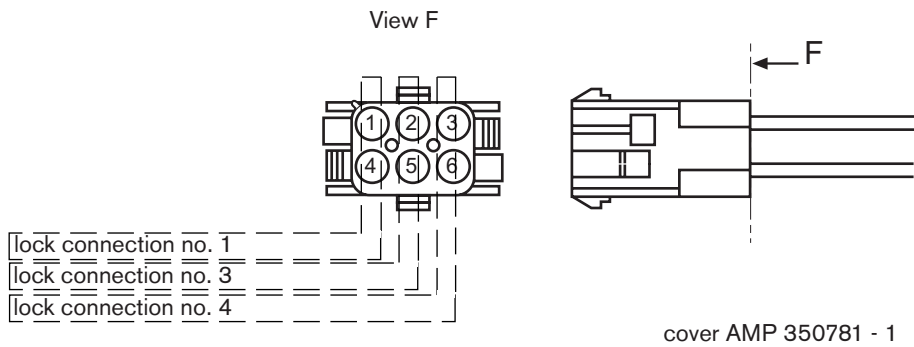

- Plug for wiring the 6 THF 5 electro-magnetic lock solenoids (ports 5, 6)

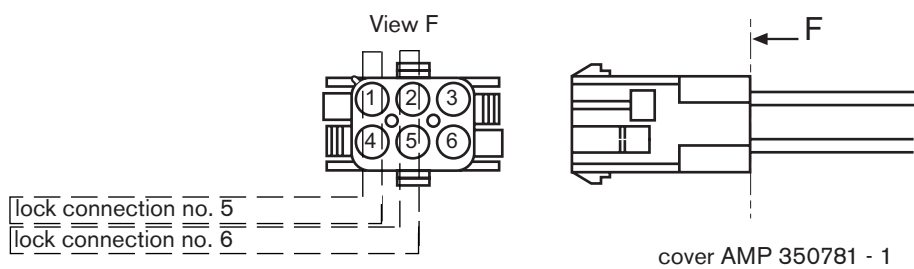

## Application guidelines (these guidelines are not intended to be considered as complete)

- Limit the control pilot circuit pressure to 35 bars maximum for a good resistance of the electrical detents.
- Do not direct the jet of a pressure washing unit directly at the unit.
- The electrical cable must be kept free of any mechanical forces.
- During operation protection via the rubber boot must be ensured.
- Only use the unit with its original grip and lever.
- Ensure that the inertia data of the original grip are not exceeded.
- Replace worn push buttons, so that the integrity of the EC2000 grip is ensured.

## Safety guidelines (these guidelines are not intended to be considered as complete)

- Only one function control must be allocated to an E-contact.
- The circuit functions are to be so designed that uncontrolled machine movements caused by the application are prevented and that it is possible to switch from one function to another.
- Take into account all of the application limits, particularly those application limits stated within this catalogue sheet.
- Preparation for assembly and testing on the machine: The various checks must include all the functions of the pilot control device.

## Installation guidelines

- Mounting flange area: Flatness = 0.5 mm
- Screw head dimensions =  $\varnothing$  10 mm
- Dimensions of shims (large M6) placed underneath the screw heads =  $\varnothing$  18 mm
- Tightening torque for the flange fixing screws = Max. 10 Nm
- Tightening torque for the pipe connections = Max. 30 Nm

### Installation hole 4 THF 5

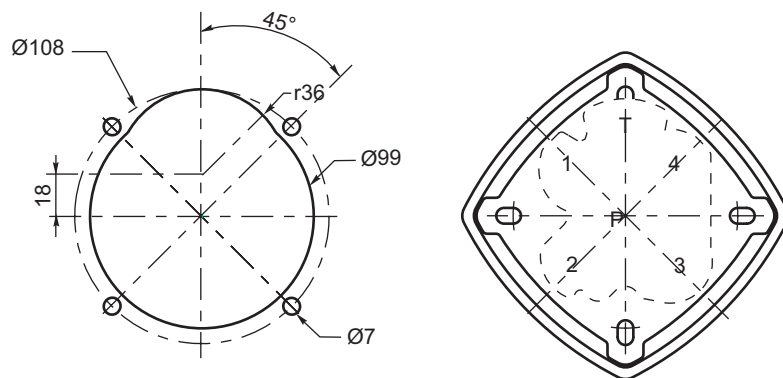

- $\varnothing$  108 = nominal diameter / fixing via 4 screws and 4 shims

### Installation hole 6 THF 5

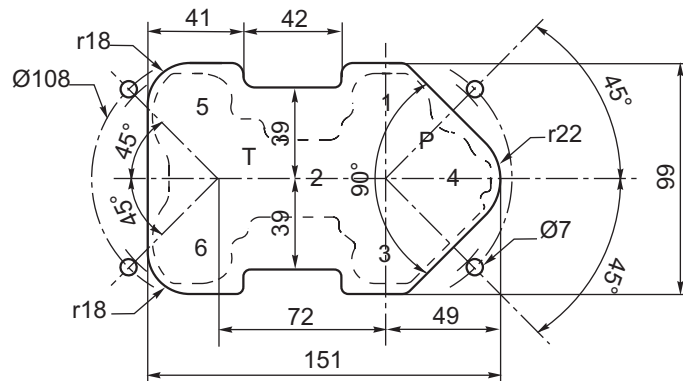

- 72 mm = between axis
- Fixing via 4 screws and 4 shims

# Notes

Bosch Rexroth AG  
Hydraulics  
Produktsegment  
Axialkolbenmaschinen  
Werk Elchingen  
Glockeraustraße 2  
89275 Elchingen, Germany  
Tel. +49 (0) 73 08 82-0  
Fax. +49 (0) 73 08 72 74  
info.brm-ak@boschrexroth.de  
www.boschrexroth.com/brm

Bosch Rexroth DSI S.A.S.  
BP 101  
91, bd Irène Joliot-Curie  
69634 Vénissieux Cedex, France  
Tel. +33 (0) 4 78 78 52 52  
Fax. +33 (0) 4 78 78 52 26  
www.boschrexroth.fr

© This document, as well as the data, specifications and other information set forth in it, are the exclusive property of Bosch Rexroth AG. It may not be reproduced or given to third parties without its consent.

The data specified above only serve to describe the product. No statements concerning a certain condition or suitability for a certain application can be derived from our information. The information given does not release the user from the obligation of own judgment and verification. It must be remembered that our products are subject to a natural process of wear and ageing.

**Subject to revision.**